



CONSTRUCTION OR RECONSTRUCTION OF STANDARD FOOTPATH CROSSINGS

General Information

1. Where kerb and gutter exists, Council will permit owners' contractors to construct a standard concrete layback in the kerb in accordance with Council's Standard Drawing No's. DS1, DS7, DS8, DS9 & DS10. The work is to be inspected and approved by Council's Civil Assets Inspector, as set out in this document.
2. Footpath crossings are not to be constructed unless an approved layback already exists or where one is incorporated into the footpath crossing construction.
3. Where an approved layback exists, Council will permit the construction of a footpath crossing in accordance with the enclosed standard drawings.

Standard Requirements

- An application and payment of inspection fees must be made prior to commencing any construction within the road reserve (property boundary to property boundary).
- The minimum width of any footpath crossing shall be **3.0 metres for residential** (unless an existing narrow layback is to be used) and **5.5 metres for light commercial areas** as indicated in Standard Drawing DS8 & DS9.
- The maximum width of any footpath crossing shall be **5.5 metres for residential and 7.2 metres for light commercial areas**.
- Crossing widths and construction details for heavy commercial or industrial sites must be designed to suit and plans submitted to the Supervisor Civil Assets for approval.
- The number of crossings permitted shall be limited to one per property with frontages up to 18 metres and two where the frontage exceeds 18 metres. Where two crossings are permitted, a minimum separation of 7 metres must be provided. Location of existing trees and utility services etc. may prevent the installation of two crossings.
- Footpath crossings shall be constructed at right angles to the kerb and gutter or road centre-line where practicable. In special circumstances, including the requirement to avoid obstructions, and subject to prior approval, this angle may be reduced to not less than 60 degrees to the kerb and gutter or the centre-line of the road, as indicated in Standard Drawing DS8 & DS9.

Levels

- The required boundary level must be determined by the contractor based on the attached vehicular crossing profile (DS10). A longitudinal section along the entire driveway from garage door to road centre line is required to be submitted to ensure compliance with Council Standard drawing DS10.
- Any change in slope of the vehicular access at/or within the property boundary should be designed to avoid vehicles scraping. The grade of the driveway within the property, are matters for determination by the owner and for which Council cannot accept any liability.
- The longitudinal street grade or slope of the driveway at the property boundary must follow the grade of the adjoining kerb and gutter.

Inspection

- Council's Asset Inspector must be given a minimum 24 hours notice for formwork inspections. Requests for inspection made after 2pm will not be scheduled for the following day. **Work must not proceed until the inspection is complete and approval to pour has been given.**
- Inspections will only be carried out between 8.00am and 11.00am, Monday to Friday. Please call 9806 8250 for bookings.



CONSTRUCTION OR RECONSTRUCTION OF STANDARD FOOTPATH CROSSINGS

Specification

1. All works shall be completed to the satisfaction of the Supervisor Civil Assets or his nominated representative.
2. **All Footpath Crossings shall be constructed in Plain Concrete** using ready mixed concrete to thickness and with reinforcement as shown on Standard Drawing DS8 or DS9. Concrete strength shall be no less than 25 MPa at 28 days and the surface shall be broomed or wood float finish. Expansion jointing shall be placed to the full depth of the slab against existing or new dish gutter or layback, existing concrete footpath and at the property boundary line. **No other material, colouring or surface treatment will be permitted unless the crossing is in the CBD or Neighbourhood Centre.**

All footpath crossings constructed within the Parramatta CBD area or Neighbourhood Centres, are to comply with the appropriate paving policy.

Council will accept no liability for the restoration of any damage caused to this type of crossing by any public utility, authority or other person, and this is a condition of approval for the construction of paved crossings.

3. It is the owner's/contractors responsibility to ensure that work is carried out in a safe manner without inconvenience to users of the road or footpath. The owner shall ensure that the works are properly barricaded and lit in accordance with Australian Standard AS 1742.3 *Traffic Control Devices for Works on Roads*, and that he/she and his/her contractor comply with the provisions of the NSW Occupational Health and Safety Act 2000. It is also the owner's responsibility to ensure he/she and his/her contractor carries adequate public liability insurance. Council will accept no liability for injury or damage to any person or thing during the course of the work
4. The owner of the property shall negotiate with any public utility or statutory authority (including Council) whose services may be affected by the proposed crossing and shall bear the full cost of any alterations required to such services. On any State Road / Regional Road (list attached) or other high risk location e.g. near school, shops or traffic lights etc., the crossing is to be constructed in 2 stages such that pedestrian access is not impeded. Safe pedestrian access is to be provided past the works in accordance with Australian Standard AS 1742.3. On all other roads, barricades or bollards with flashing lights are to be placed adjacent to the work to allow a 1.5m wide pedestrian access along the roadway. Appropriate signage is to be placed in the street to advise motorists of the work.
5. Works undertaken must be complete to the satisfaction of the Asset Inspector, inclusive of all restoration, adjustment of adjoining footpath or verge surfaces, relocation of services, and any other works deemed necessary, with all costs for such works to be borne by the owner/contractor.
6. Where an existing layback or dish gutter is made redundant by the construction of the new crossing, they are to be removed and replaced with a standard kerb construction (see DS1). Any disused driveway surface is to be removed and the area re-grassed to the satisfaction of the Asset Inspector.
7. Crossings on corner allotments are not to be constructed within 6 metres of the intersection of street alignments.



8. Crossings shall not encroach over the frontage of an adjoining allotment without prior approval of Council. Applicants should seek the written agreement of the neighbouring property owner and submit this for Council consideration.

NOTE

Unless existing gutter is damaged, it shall not be removed without the approval of the Asset Inspector. Preference is given to removal of kerb profile or existing layback only and the new construction secured to existing gutter by 300mm Y12 dowels at 600mm centres. Where the removal of existing gutter is unavoidable the owner shall make allowance for reinstatement of the road surface in the event that it is damaged during the removal.

Restoration of the road surface shall be carried out to the following specification.

1. Saw-cut existing road surface a minimum of 500mm parallel to the gutter construction and remove the bituminous material to a minimum depth of 70mm.
2. Replace the bituminous material with minimum AC10 Hot Mix compacted in accordance with AUSSPEC #2, Specification 306. The evenness of the resulting restored surface shall be such that an impact is not transmitted to traffic passing over the restoration.
3. The roadway shall be restored in a continuous manner to a condition equivalent to that existing at the commencement of the work.
4. All edges adjoining existing bituminous/asphalt surfaces are to be sealed with an approved rubberised bitumen seal.

Definition of Terms

1. Footpath Crossing:

The area between the kerb and gutter and the property boundary, which is used to drive from the roadway into the property.

Also sometimes called; crossing, vehicular crossing, vehicular entrance, driveway, vehicular access.

2. Footpath

The area between the kerb and gutter and the property boundary. Also sometimes called; verge, footway, nature strip.

Note: a constructed concrete or asphalt (bitumen) footpath may form part of the wider term 'footpath' used in this document.

3. Layback

The "flattened" part of the kerbing which is used for driving a vehicle across the footpath. Please note that "roll kerbing" does not require the construction of a layback.

Also sometimes called; a gutter crossing.

As most of Council's roads have kerb and gutter, the use of the term layback is sufficient. However, there will be places where the term "gutter crossing" may be used to describe the physical structure which provides access from the roadway to the footpath.



RMS State and Regional Roads

Regional Roads

- Albert Street (Church St to O'Connell St) – North Parramatta
- Barclay Road (Renown Rd to North Rocks Rd) – North Rocks
- Barney Street (Church St to O'Connell St) – North Parramatta
- Bettington Road (Kissing Point Rd to Pennant Hills Rd) - Oatlands
- Bold Street (Railway Pde to Parramatta Rd) – Granville
- Burnett Street (Western Motorway to Great Western Hwy) – Mays Hill
- Darcy Road (Hawkesbury Rd to Hart Dr/Cumberland Hwy) - Westmead
- Fitzwilliam Road (Old Windsor Rd to Station Rd) – Toongabbie
- Harris Steet (George St to Parkes St) - Parramatta
- Hassall Street (Parkes St to James Ruse Drive) – Parramatta
- Hawkesbury Road (Alexandra Ave to Darcy St) - Westmead
- Hill Road (M4 to Holker St) – Homebush
- Holker Street (Hill Rd to Silverwater Rd) – Homebush
- Jenkins Road (Pennant Hills Rd to North Rocks Rd) - Carlingford
- MacArthur Street (Victoria St to George St) - Parramatta
- Macquarie Street (O'Connell St to Pitt St) – Parramatta
- North Rocks Road (Windsor Rd to Pennant Hills Rd) – North Rocks
- Oakes Road (North Rocks Rd to Aiken Rd) – North Rocks
- O'Connell Street (Great Western Hwy to Barney St) – Parramatta
- Park Parade (Pitt St to Alexandra Ave) - Westmead
- Parkes Street (Church St to Hassall St) – Parramatta
- Pennant Hills Road (Church St to James Ruse Dr) – North Parramatta
- Pennant Street (James Ruse Dr to Victoria St) – Parramatta
- Pitt Street (Western Motorway to Macquarie St) – Parramatta
- Station Road (Fitzwilliam Rd to Ccl Boundary) – Toongabbie
- The Portico (Railway Overbridge to Wentworth Ave) - Toongabbie
- Victoria Road (Church St to O'Connell St) – Parramatta
- Wentworth Avenue (Cumberland Hwy to Fitzwilliam Rd)

Regional Roads formerly with City of Parramatta – now Cumberland Council

- Boundary Road (Ferndell St to Hector St) – South Granville
- Clyde Street - Granville
- Ferndell Street – South Granville
- Hector Street – South Granville
- Loftus Street - Guildford
- Memorial Drive (Bold St to Clyde St) – Granville
- Merrylands Road – Merrylands
- Mombri Street - Guildford

- Oxford Street - Guildford
- Railway Terrace – Guildford
- Randle Street - Granville
- Rawson Road – Guildford
- Wellington Road – South Granville

State Roads

- Beecroft Road
- Blaxland Road, Epping
- Briens Road (Cumberland Highway)
- Carlingford Road
- Church Street (Windsor Road to Victoria Road)
- Church Street (Parkes Street to Woodville Road)
- Epping Road
- Great Western Highway
- Hart Drive (Cumberland Highway)
- James Ruse Drive
- Kissing Point Road (James Ruse Drive to Stewart St)
- Marsden Road, Epping
- Old Windsor Road
- Parramatta Road (Great Western Highway)
- Pennant Hills Road (James Ruse Dr to M2)
- Silverwater Road
- Stewart Street – Dundas
- Terry Road
- Victoria Road (East of Church Street)
- Windsor Road
- Wingate Avenue, Epping
- Woodville Road

NOTE: for all work on or near both State and Regional roads, or within 100m of traffic lights, clearance from the RMS is also required. Please contact the following departments at least 14 days before commencing any construction work:

- Traffic Management Centre (TMC) - 18 Lee Street Chippendale NSW 2008
Phone: (02) 8202 2200
- Downermoucel - 116 Epping Road Lane Cove West NSW 2066
Brendan Tukuafu
Phone 0400 912 808
02 8565 8121

Parramatta City Council Contact numbers:

- Restorations and Road Opening Permits 9806 8250
- Catchment Management (Drainage) 9806 8250
- Tree Management 9806 8273
- Traffic 9806 5000
- Development Services 9806 5000

Other Useful Contact Numbers

- Telstra 13 22 03
- Sydney Water (report Damage) 13 20 90
- Jemena (gas) - Emergencies 131 626
- Connection inquiry 1300 137 078
- Endeavour Energy - Emergencies 131 003
- Contact 133 718
- Dial before You Dig 1100 (business hours)
or www.1100.com.au



Before requesting a final inspection for works outside the property boundary please ensure that the following has been completed.

1. All works outside the property boundary associated with the development must have been inspected by council.
2. That all works have been completed in accordance to the City of Parramatta Council specifications & standards.
3. The nature strip has been restored with back fill & turfed. This includes all landscaping works if required. Please ensure that when back filling with soil it is compacted next to the new concrete works so that there are no depressions.
4. All Road Opening Permits (ROP) have been inspected by council's Restoration Officers and have been paid and that all the works associated with said ROP have been completed. To arrange an inspection or final payment contact the restoration officers on 9806 8250 or email at restore@parracity.nsw.gov.au

Before requesting a bond release for the development.

1. A request for the bond release must be submitted as per the Development Application (DA) in writing. Please send request to Council's Supervisor Civil Assets via email footpathcrossings@parracity.nsw.gov.au . Please ensure that all the DA conditions have been met and completed before requesting your bond release.
2. All works have been completed as per notes above & final inspection certificated has been received from council.
3. All work must be completed to the development both inside & out.
4. No heavy machinery, heavy materials or skip bins are to be left on site. This is to ensure that council's assets will not be damage when machinery, heavy materials or skip bins are removed.
5. All fencing must be removed from council's property.

TO PROCEED TO THE ONLINE APPLICATION, PLEASE CLICK ON THE LINK BELOW:

www.parracity.nsw.gov.au/eservices/eservices_portal/portal

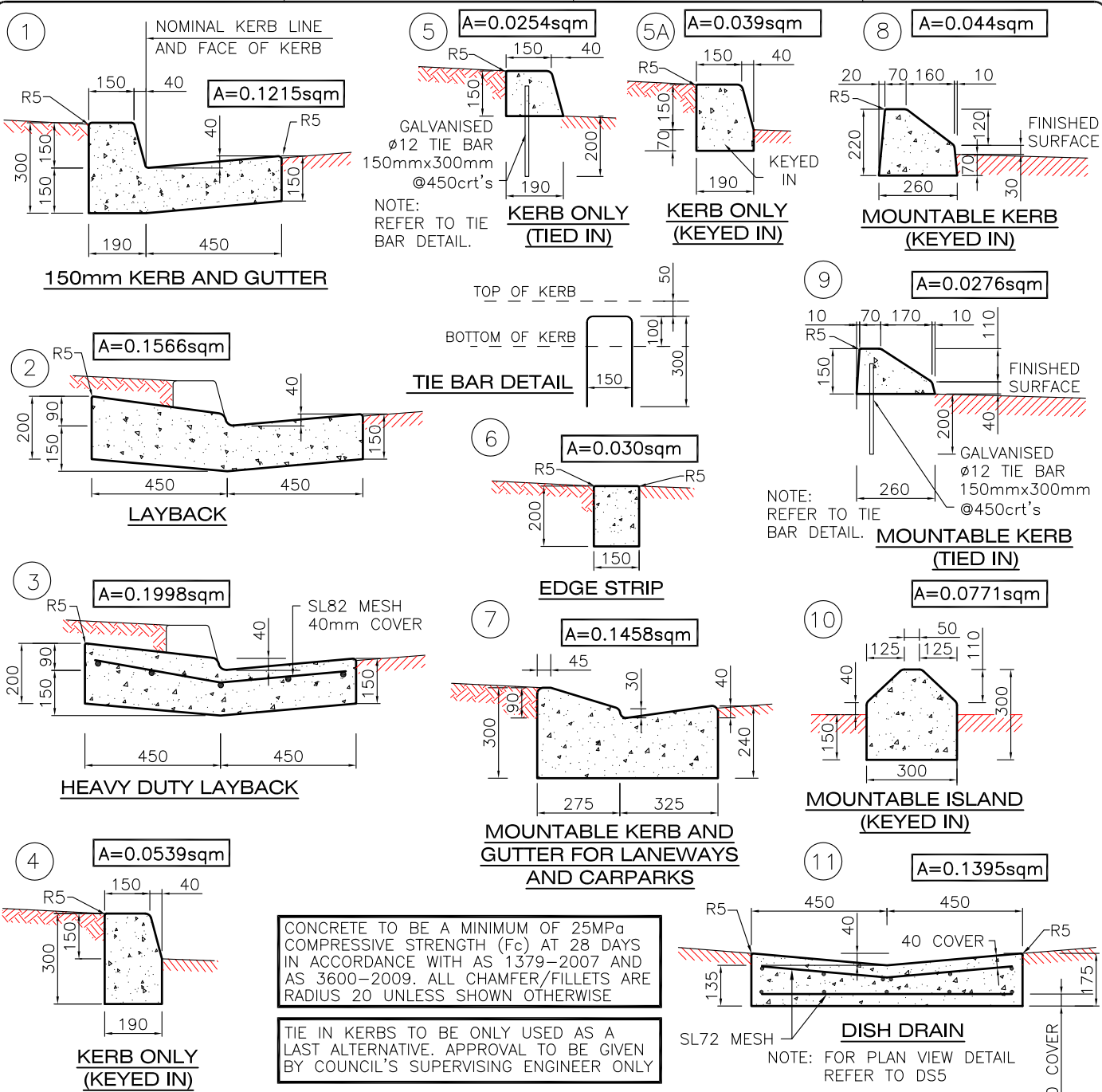

CONCRETE TO BE A MINIMUM OF 25MPa COMPRESSIVE STRENGTH (Fc) AT 28 DAYS IN ACCORDANCE WITH AS 1379-2007 AND AS 3600-2009. ALL CHAMFER/FILLETS ARE RADIUS 20 UNLESS SHOWN OTHERWISE

TIE IN KERBS TO BE ONLY USED AS A LAST ALTERNATIVE. APPROVAL TO BE GIVEN BY COUNCIL'S SUPERVISING ENGINEER ONLY

NOTES

- ROAD BASE MATERIAL IS TO BE DGB20 OR SIMILAR AND COMPACTED TO 100% STANDARD MAXIMUM DRY DENSITY IN ACCORDANCE WITH AS 1289.5.1.1-2003
- ROAD BASE MATERIAL 150mm THICK TO BE PLACED BENEATH KERB & GUTTER AND 300mm BEYOND THE EXTERNAL EDGES OF KERB & GUTTERS, APRONS, AND CROSSINGS.
- ALL DISTURBED AREAS TO BE TOPSOILED WITH 75mm OF APPROVED LOAM AND TURFED AS SOON AS PRACTICABLE TO ENCOURAGE REVEGETATION AND MINIMISE SOIL EROSION FROM SITE.
- PROVIDE SAWCUT AND REINSTATE 500mm INTO ROAD PAVEMENT FROM FRONT EDGE OF CONCRETE WORKS UNLESS OTHERWISE INSTRUCTED BY COUNCIL'S INSPECTOR.

- REINSTATE PAVEMENT WITH 175mm DEPTH DEEP LIFT (AC14) AND 30mm DEPTH AC10 COMPACTED TO 95% MODIFIED (97% MAX) TO RMS SPECIFICATIONS R116 AND R117. CRACK SEAL ALL BITUMEN TO BITUMEN FACES. AC 14 TO BE COMPACTED IN LAYERS. EACH LAYER TO BE OF 40-70mm THICKNESS
- APPROVED FULL DEPTH EXPANSION JOINTS (10mm) TO BE PROVIDED AS FOLLOWS:
 - BETWEEN NEW AND EXISTING WORKS
 - BETWEEN LAYBACK WINGS AND KERB
 - EITHER SIDE OF ANY LINTELS
 - AT EVERY 6m INTERVALS ALONG CONTINUOUS LENGTHS (PROVIDE A DUMMY JOINT AT EVERY 3m INTERVALS UNLESS INSTRUCTED OTHERWISE BY SUPERINTENDENT)
- ALL SURFACES TO BE STEEL TROWEL FINISHED.
- ROOFWATER OUTLETS TO BE APPROVED IN ACCORDANCE WITH STANDARD DRAWING DS2
- USE CLEAN FILL AS BACKFILL MATERIAL UNLESS INSTRUCTED OTHERWISE

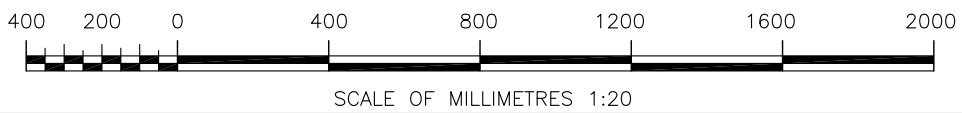

Scale: 1:20		FINAL		CITY OF PARRAMATTA COUNCIL		PLAN N°	
DESIGNED / DRAWN	Date:	ASSET OWNER		KERBS AND LAYBACKS		DS1	
DESIGN CHECKED & APPROVED	Date:					Sheet No : 1 of 1	
SERVICE MANAGER CAPITAL PROJECTS	Date:					Revision :	
		MANAGER CITY ASSETS & ENVIRONMENT		SECTION DETAILS AND NOTES			

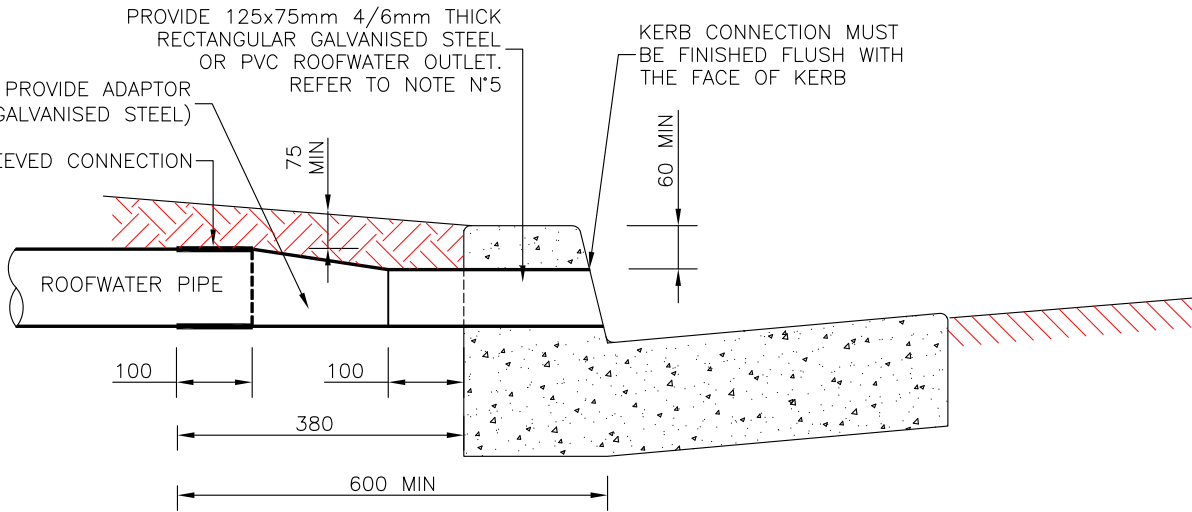

ROOFWATER OUTLET CONNECTION - (FOR NEW AND EXISTING)

SCALE 1:10

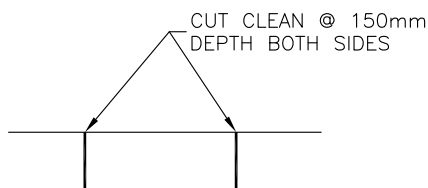

FRONT VIEW PLAN
N.T.S.

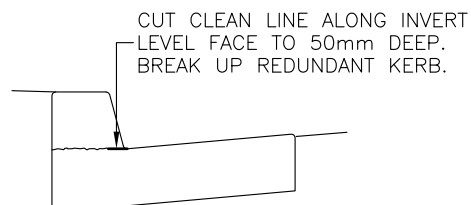

PROFILE SECTION
N.T.S.

KERB SAW CUTTING DETAILS - (FOR REPLACEMENT OF EXISTING)

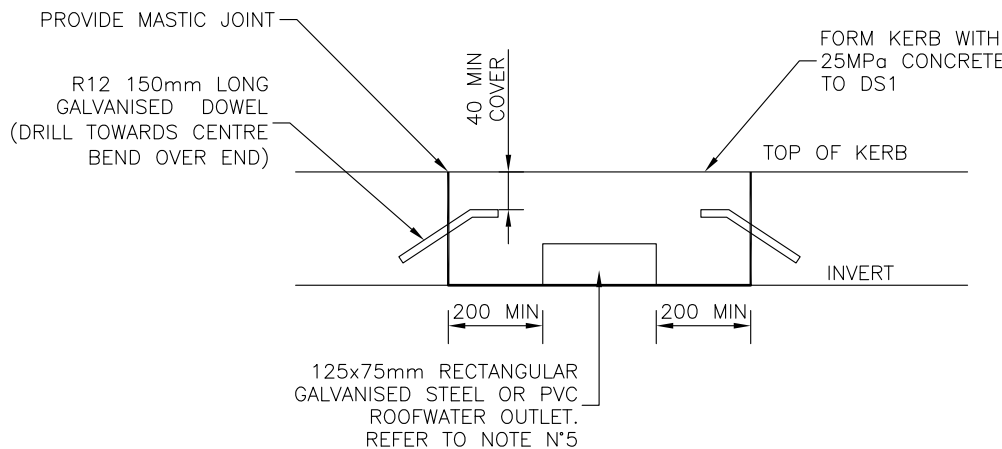

FRONT VIEW SECTION - (FOR REPLACEMENT OF EXISTING)

N.T.S.

NOTES

- ENSURE THAT ALL CONNECTIONS ARE WATER TIGHT.
- FOR TRAFFICABLE AREAS SUCH AS DRIVEWAYS, USE RECTANGULAR GALVANISED STEEL ROOFWATER OUTLET FOR FULL LENGTH, EG. BOUNDARY TO KERB.
- ALL DIMENSIONS ARE IN MILLIMETRES UNLESS OTHERWISE SHOWN.
- REPLACE EXISTING PIPE SECTION BETWEEN PROPERTY LINE AND KERB FOR ALL KERB AND GUTTER RECONSTRUCTION WORKS.
- WHERE ROOFWATER OUTLETS ARE LOCATED NEAR DRIVEWAYS, OUTLET IS TO BE GALVANISED STEEL AND POSITIONED A MINIMUM 600mm FROM THE DRIVEWAY. OUTLETS ELSEWHERE MAY BE PVC UNLESS DIRECTED OTHERWISE.



SCALE OF MILLIMETRES 1:10

DESIGNED / DRAWN Date:	Scale: AS SHOWN	FINAL	CITY OF PARRAMATTA COUNCIL	PLAN N°	
	DESIGN CHECKED & APPROVED Date:	ASSET OWNER		Date:	ROOFWATER OUTLET
	SERVICE MANAGER CAPITAL PROJECTS Date:	MANAGER CITY ASSETS & ENVIRONMENT		Date:	SECTION DETAILS AND NOTES
				DS2	
				Sheet No : 1 of 1	
				Revision :	

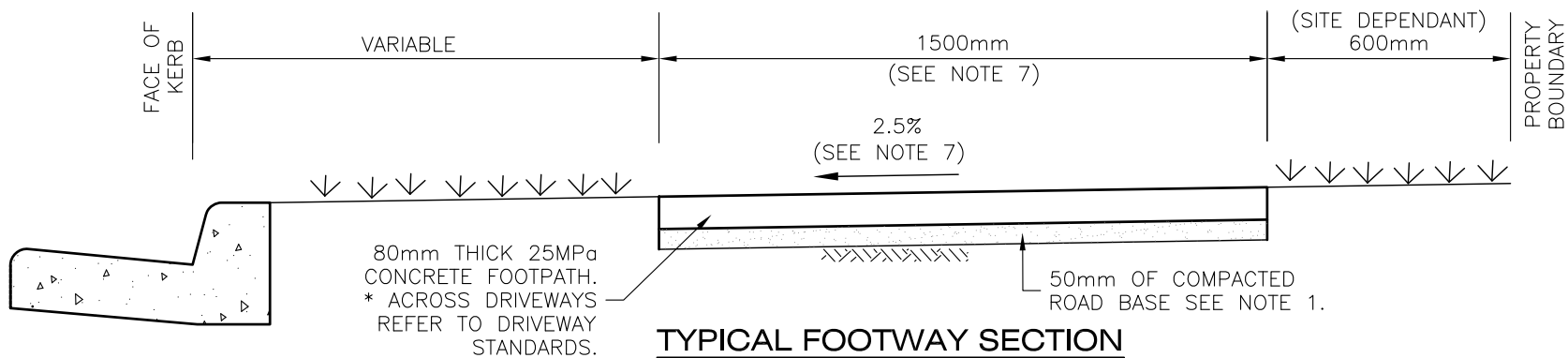

NOTES

1. BASE MATERIAL IS TO BE DGB20 OR SIMILAR. COMPACT TO 100% STANDARD MAXIMUM DRY DENSITY IN ACCORDANCE WITH A.S. 1289.5.1.1-2003
2. CONCRETE IS TO BE 25MPa IN ACCORDANCE WITH AS 1379-2007 AND AS 3600-2009
3. PROVIDE FULL DEPTH EXPANSION JOINT 10mm WIDE AT 6m SPACING, PROVIDE TOOLED DUMMY JOINTS 10mm WIDE BY 10mm DEEP AT 1.5m SPACING.
4. ALL SURFACES TO BE BROOM FINISHED AT 90° TO DIRECTION OF TRAVEL AND EDGES TO BE ROUNDED TO 20 RADIUS USING AN EDGING TOOL. (NO WOOD FLOAT FINISH PERMITTED)
5. ADJOINING NATURAL FOOTWAY IS TO BE CUT OR FILLED WITH TOPSOIL AS REQUIRED TO GRADE EVENLY TO THE FOOTPATH. ALL DISTURBED AREAS TO BE TOPSOILED WITH 75mm APPROVED LOAM AND TURFED AS SOON AS PRACTICABLE TO ENCOURAGE REVEGETATION AND MINIMISE SOIL EROSION FROM SITE, OR REINSTATED AS DIRECTED BY COUNCIL'S INSPECTOR OR PROJECT MANAGER.
6. FOOTPATH IS TO BE A CONSTANT HEIGHT ABOVE TOP OF KERB WHERE POSSIBLE. TRANSITIONS IN GRADE TO MATCH EXISTING VEHICULAR FOOTWAY CROSSING (VFCs) ARE NOT TO EXCEED A GRADE OF 1 IN 14 TO COMPLY WITH AS 1428.1
7. FOOTPATH WIDTH AND CROSS FALL AS SHOWN ABOVE UNLESS DIRECTED OTHERWISE BY THE SUPERINTENDENT / PROJECT MANAGER
8. PROVIDE ARTICULATED JOINT OR SIMILAR IF FOOTPATH IS ADJACENT TO TREES AND WHERE NON-UNIFORM SOIL MOVEMENT IS EXPECTED.
9. ALL DIMENSIONS ARE IN MILLIMETRES UNLESS OTHERWISE SHOWN.

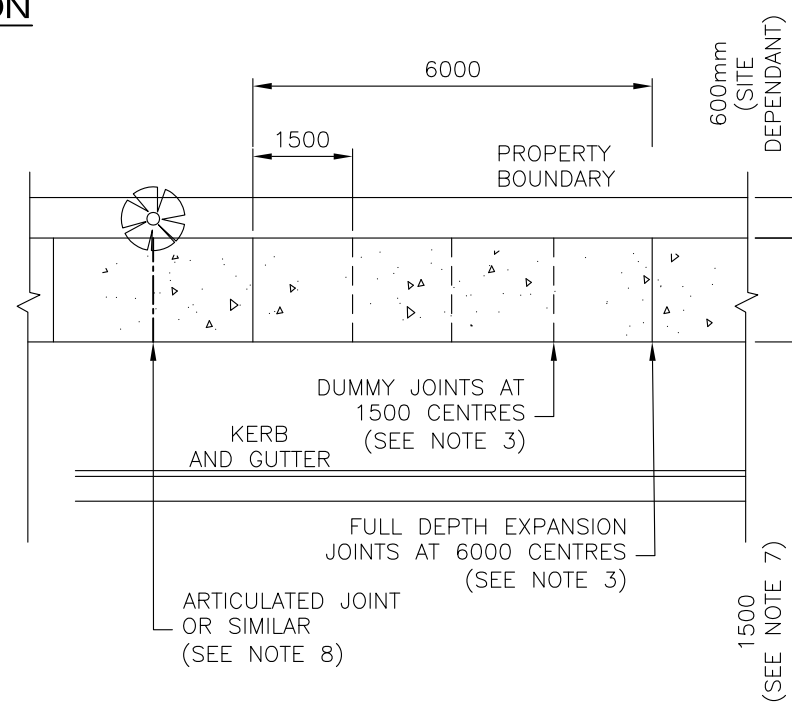

AMENDMENTS				DESIGNED / DRAWN	Date:	Scale: N.T.S.	FINAL	CITY OF PARRAMATTA COUNCIL	PLAN N°		
No.	DETAIL	DATE	CHECKED								
				DESIGN CHECKED & APPROVED	Date:	FOOTPATH			DS3		
				SERVICE MANAGER CAPITAL PROJECTS	Date:				ASSET OWNER	Date:	Sheet No : 1 of 1
					Date:				MANAGER CITY ASSETS & ENVIRONMENT	Date:	Revision :
						SECTION DETAILS AND NOTES					

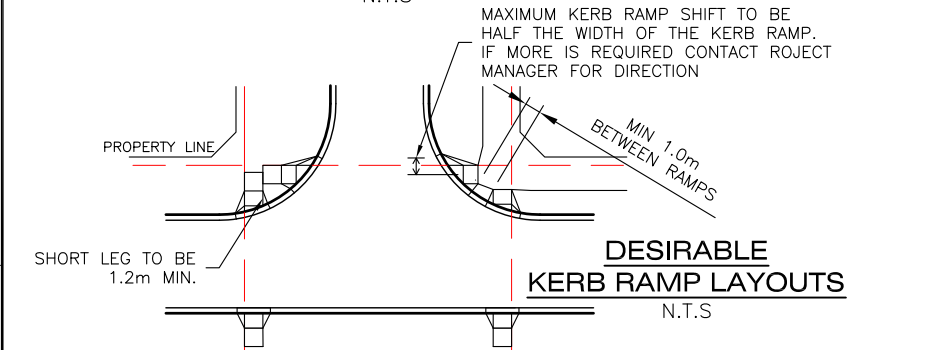
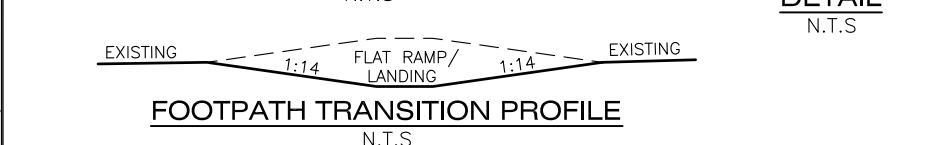
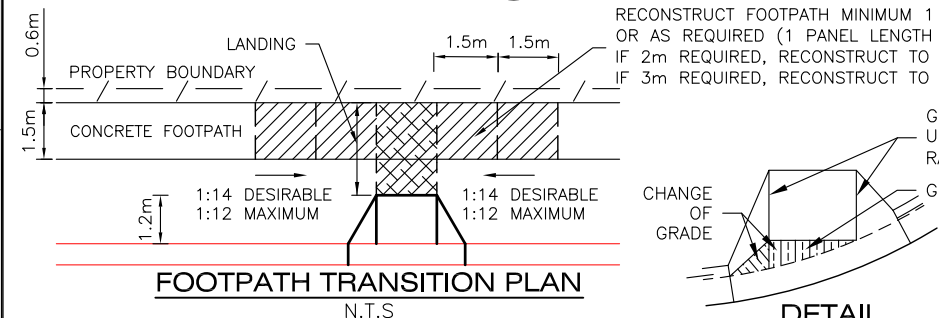
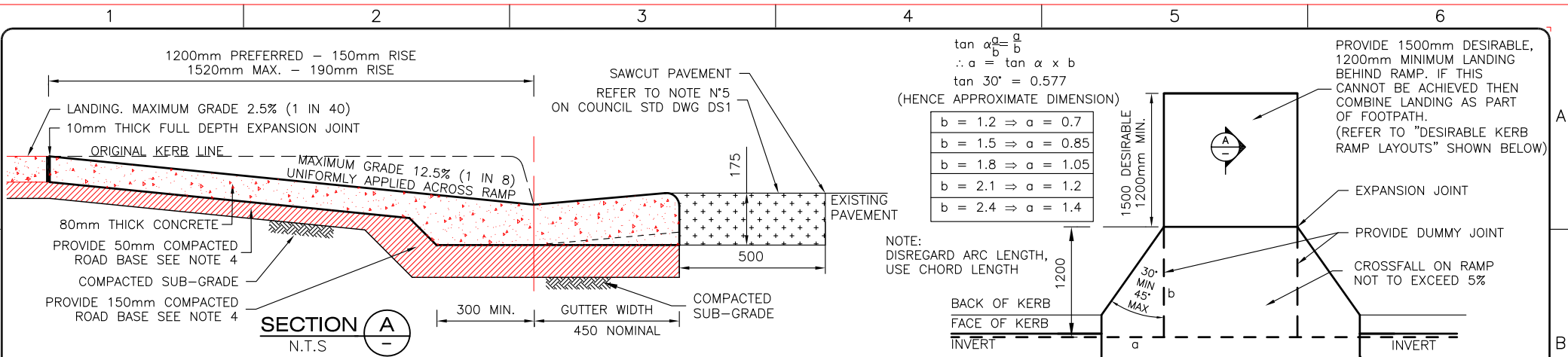

NOTES

- DESIGN OF THE STANDARD KERB RAMP IS BASED ON AS 1428.1-2009/AMDT1-2010
- FOR KERB RAMP LOCATION REFER TO DESIGN PLANS OR AS INSTRUCTED BY CITY OF PARRAMATTA COUNCIL OFFICER.
- CONCRETE TO BE 25MP_a IN ACCORDANCE WITH AS 1379-2007 AND AS 3600-2009
- ROAD BASE MATERIAL IS TO BE DGB20 OR SIMILAR. COMPACT TO 100% STANDARD MAXIMUM DRY DENSITY IN ACCORDANCE WITH A.S 1289.5.1.1-2003
- KERB RAMP TO BE POURED AS ONE PIECE WITH GUTTER, NO CONSTRUCTION JOINTS WILL BE ALLOWED.
- PLAIN CONCRETE SURFACES TO BE FINISHED AS FOLLOWS;
RAMP – BROOM FINISH
GUTTER – STEEL TROWEL FINISH
- ALL KERB RAMPS ARE TO BE ALIGNED WITH THE DESIRED DIRECTION OF PEDESTRIAN TRAVEL. (SEE "DESIRABLE KERB RAMP LAYOUTS".)
- AT PEDESTRIAN CROSSINGS/REFUGES THE WIDTH OF THE RAMP SHOULD BE AS WIDE AS THE DEVICE OPENING.
- SHOULD DESIGN DIMENSIONS NOT BE ACHIEVABLE, CONTACT COUNCIL'S INSPECTOR.
- CONTACT COUNCIL'S INSPECTOR PRIOR TO COMMENCEMENT OF THE WORKS FOR
 - PRE INSPECTION (TO DETERMINE SCALE OF WORKS) (AN ADDITIONAL FEE FOR PRE INSPECTION IS REQUIRED.)
 - FORMWORK INSPECTION
 - ALL DISTURBED AREAS TO BE TOPSOILED AND TURFED FLUSH WITH ALL CONCRETE WORKS PRIOR TO FINAL INSPECTION.
- ALL DIMENSIONS ARE IN MILLIMETRES UNLESS OTHERWISE SHOWN.

$$\tan \alpha = \frac{a}{b}$$

$$\therefore a = \tan \alpha \times b$$

$$\tan 30^\circ = 0.577$$

(HENCE APPROXIMATE DIMENSION)

b = 1.2	⇒ a = 0.7
b = 1.5	⇒ a = 0.85
b = 1.8	⇒ a = 1.05
b = 2.1	⇒ a = 1.2
b = 2.4	⇒ a = 1.4

NOTE:
DISREGARD ARC LENGTH,
USE CHORD LENGTH

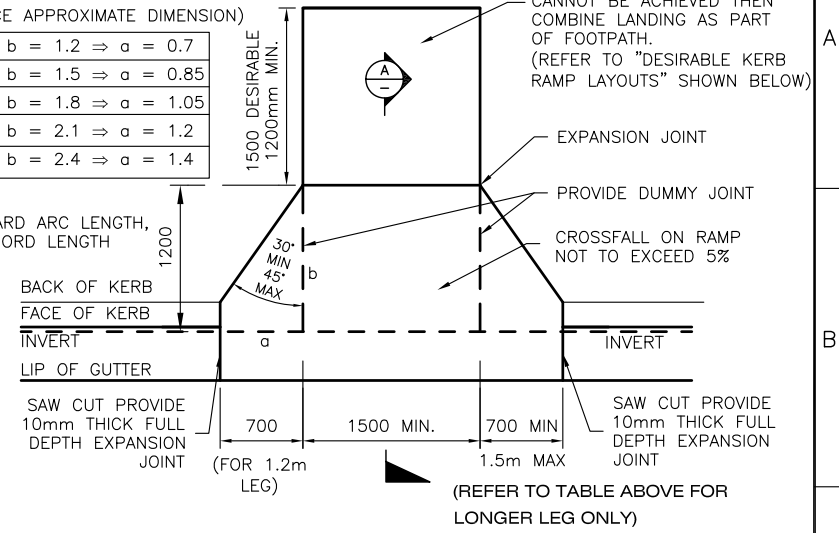

AMENDMENTS				DESIGNED / DRAWN	Date:	Scale: AS SHOWN	FINAL	CITY OF PARRAMATTA COUNCIL	PLAN N°	
No.	DETAIL	DATE	CHECKED							
1	Updates made to Notes and Details	22/11/16						KERB RAMP	DS4	
				DESIGN CHECKED & APPROVED	Date:		ASSET OWNER		Date:	Sheet No : 1 of 1
				SERVICE MANAGER CAPITAL PROJECTS	Date:		MANAGER CITY ASSETS & ENVIRONMENT		Date:	Revision :
								PLAN VIEW, SECTION DETAILS AND NOTES		

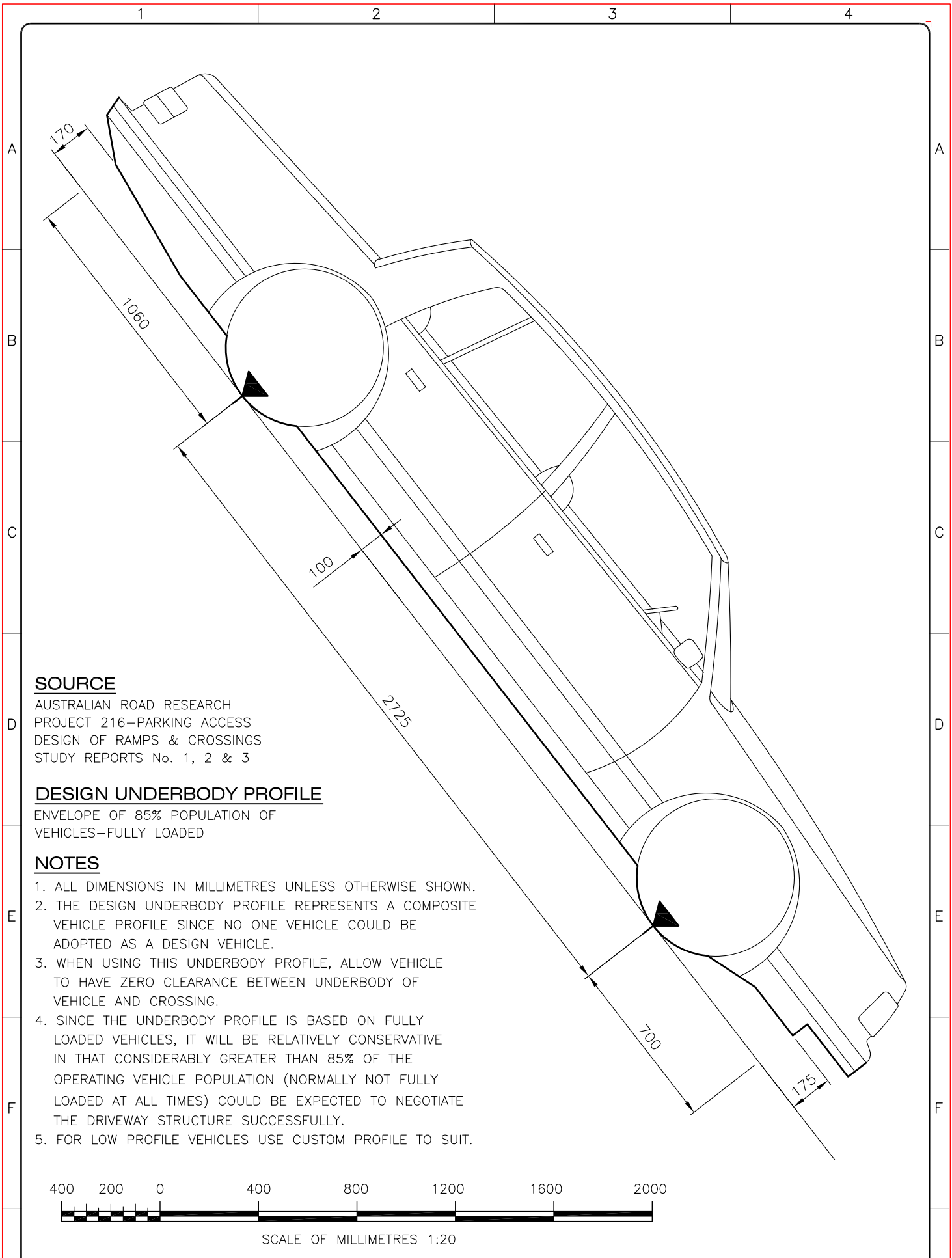

SOURCE

AUSTRALIAN ROAD RESEARCH
 PROJECT 216-PARKING ACCESS
 DESIGN OF RAMPS & CROSSINGS
 STUDY REPORTS No. 1, 2 & 3

DESIGN UNDERBODY PROFILE

ENVELOPE OF 85% POPULATION OF
 VEHICLES-FULLY LOADED

NOTES

1. ALL DIMENSIONS IN MILLIMETRES UNLESS OTHERWISE SHOWN.
2. THE DESIGN UNDERBODY PROFILE REPRESENTS A COMPOSITE VEHICLE PROFILE SINCE NO ONE VEHICLE COULD BE ADOPTED AS A DESIGN VEHICLE.
3. WHEN USING THIS UNDERBODY PROFILE, ALLOW VEHICLE TO HAVE ZERO CLEARANCE BETWEEN UNDERBODY OF VEHICLE AND CROSSING.
4. SINCE THE UNDERBODY PROFILE IS BASED ON FULLY LOADED VEHICLES, IT WILL BE RELATIVELY CONSERVATIVE IN THAT CONSIDERABLY GREATER THAN 85% OF THE OPERATING VEHICLE POPULATION (NORMALLY NOT FULLY LOADED AT ALL TIMES) COULD BE EXPECTED TO NEGOTIATE THE DRIVEWAY STRUCTURE SUCCESSFULLY.
5. FOR LOW PROFILE VEHICLES USE CUSTOM PROFILE TO SUIT.

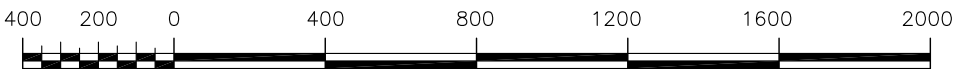

SCALE OF MILLIMETRES 1:20

DESIGNED / DRAWN Date:	Scale: AS SHOWN FINAL	CITY OF PARRAMATTA COUNCIL	PLAN N°
	ASSET OWNER Date:		PASSENGER CAR CLEARANCE PROFILE
	DESIGN CHECKED & APPROVED Date:	MANAGER CITY ASSETS & ENVIRONMENT Date:	PROFILE AND NOTES

LEGEND

BF BACK OF FOOTPATH
 FF FRONT OF FOOTPATH
 INV INVERT

DIRECTION OF BROOM FINISH

PROPERTY

APPROVED CROSSING WIDTH
 (MIN 3.0m - MAX 5.5m)

"W"



PROVIDE EXPANSION JOINT
 ALONG PROPERTY BOUNDARY
 AND AT BOTH ENDS IF
 MATCHING FOOTPATH

BOUNDARY

VARIABLE GRADE

2.5% MAX GRADE
 OVER 1.5m

PROVIDE TOOLED DUMMY
 JOINTS 10mm DEEP

EXPANSION JOINT

BACK OF KERB

FACE OF KERB

INV OF
 KERB LINE

FOOTWAY WIDTH

2.1m
 MINIMUM

(SEE NOTE
 9)



LIP OF GUTTER

LEVEL DIFFERENCE NOT TO
 EXCEED 90mm BETWEEN
 BACK OF PATH AND PROPERTY
 BOUNDARY

PLAN
 N.T.S

SAWCUT AND PROVIDE
 EXPANSION JOINT AT
 EACH END OF CROSSING.
 (WHERE APPLICABLE)

**DRIVEWAYS TO BE LAID IN PLAIN
 CONCRETE, NO COLORING,
 STAMPING OR STENCIL PATTERNS
 BETWEEN PROPERTY BOUNDARY
 AND BACK OF LAYBACK.**

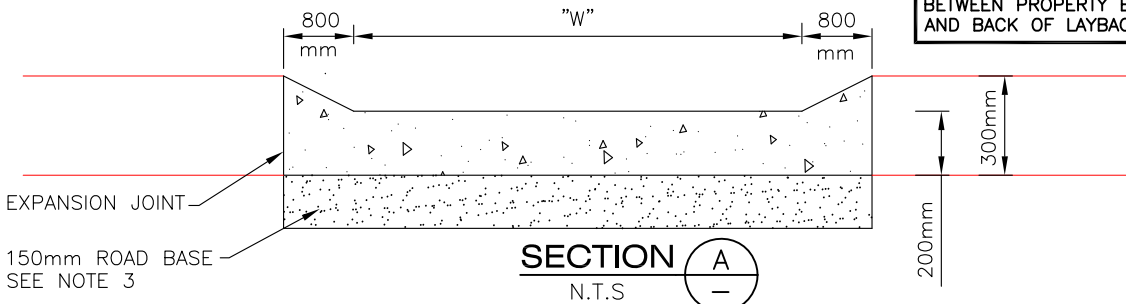

**SAWCUT AND REINSTATE 500mm
 MINIMUM INTO ROAD PAVEMENT
 FROM FRONT EDGE OF
 CONCRETWORKS UNLESS
 OTHERWISE INSTRUCTED BY
 COUNCIL'S INSPECTOR**

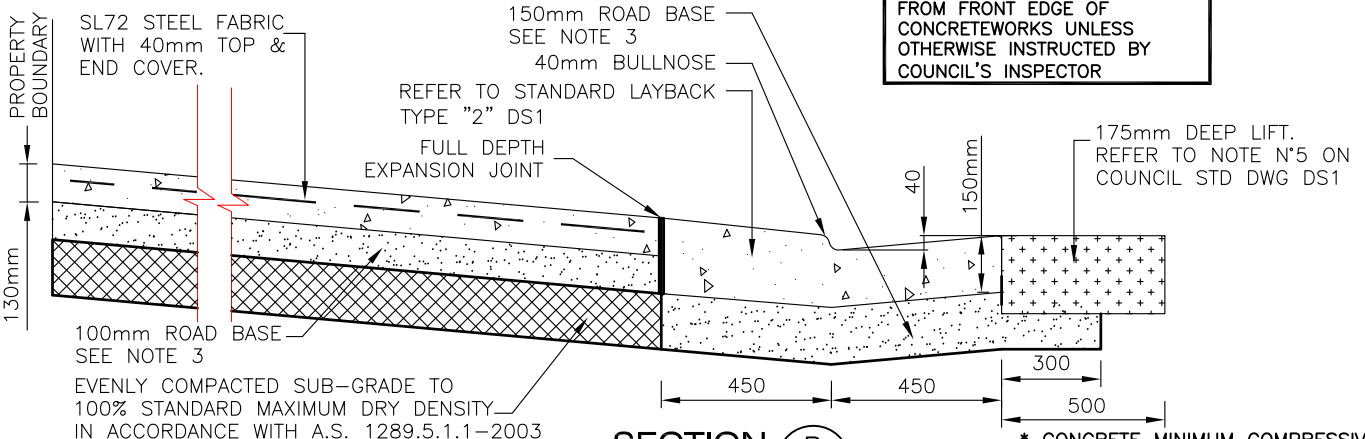

*** CONCRETE MINIMUM COMPRESSIVE
 STRENGTH TO BE (Fc) 25MPa
 AT 28 DAYS.**

NOTES

- ALL EXISTING KERB AND GUTTER SHALL BE REMOVED PRIOR TO ANY NEW LAYBACK WORKS UNLESS OTHERWISE DIRECTED BY COUNCIL'S INSPECTOR AT PRE-INSPECTION.
- VEHICULAR CROSSING LEVELS TO BE IN ACCORDANCE WITH COUNCIL STD DWG DS10 AND DETAILED DESIGN.
- ROAD BASE MATERIAL IS TO BE DGB20 OR SIMILAR AND COMPACTED TO 100% STANDARD MAXIMUM DRY DENSITY IN ACCORDANCE WITH A.S. 1289.5.1.1-2003
- ALL DISTURBED AREAS TO BE TOPSOILED WITH 75mm OF APPROVED LOAM AND TURFED AS SOON AS PRACTICABLE (PRIOR TO FINAL INSPECTION) TO ENCOURAGE REVEGETATION AND MINIMISE SOIL EROSION FROM SITE.
- EXISTING CONCRETE FOOTPAVING IS TO BE RECONSTRUCTED AS REQUIRED BY COUNCIL'S INSPECTOR OR PROJECT MANAGER TO MATCH THE CROSSING.
- THE FOOTWAY IS TO BE SHAPED AS REQUIRED BY COUNCIL'S INSPECTOR OR PROJECT MANAGER TO THE CROSSING EVENLY.
- THIS PLAN DOES NOT APPLY FOR FOOTWAY WIDTHS LESS THAN 2.8m.
- ALL SURFACES TO BE BROOM FINISHED.
- USE 2.0m, IF DISTANCE BETWEEN INVERT AND FRONT OF FOOTPATH IS 2.0m OR GREATER, WHERE DISTANCE IS LESS THAN 2.0m WING TO MATCH FRONT OF FOOTPATH

400 200 0 400 800 1200 1600 2000

SCALE OF MILLIMETRES 1:20

DESIGNED / DRAWN		Date:	Scale: AS SHOWN	FINAL	CITY OF PARRAMATTA COUNCIL	PLAN N°
DESIGN CHECKED & APPROVED		Date:	ASSET OWNER	Date:		VEHICULAR CROSSING
SERVICE MANAGER CAPITAL PROJECTS		Date:	MANAGER CITY ASSETS & ENVIRONMENT	Date:	PLAN, SECTIONS AND NOTES	Sheet No : 1 of 1
						Revision :

LEGEND

- BF BACK OF FOOTPATH
- FF FRONT OF FOOTPATH
- INV INVERT
- DIRECTION OF BROOM FINISH

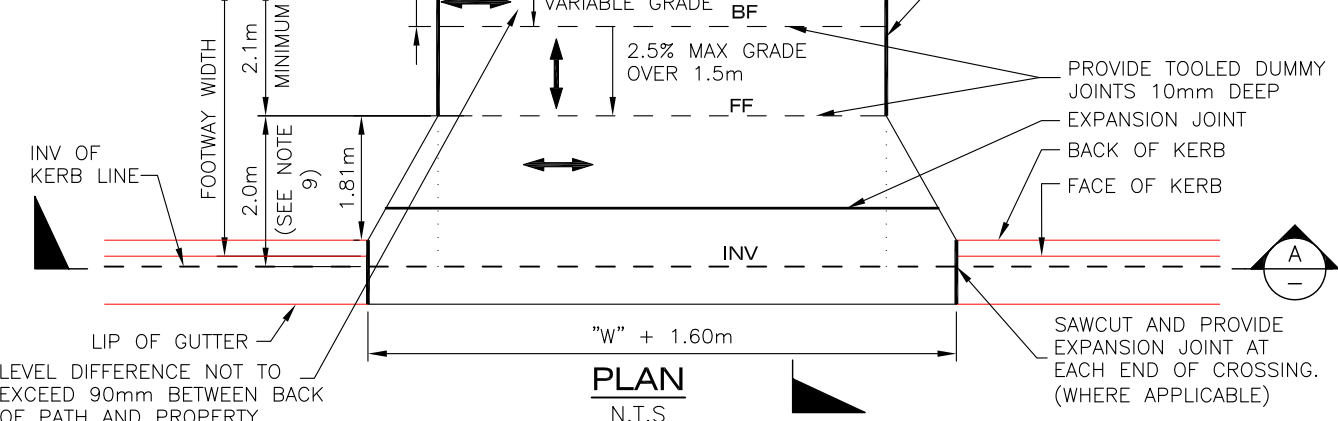

PLAN
N.T.S

DRIVEWAYS TO BE LAID IN PLAIN CONCRETE, NO COLORING, STAMPING OR STENCIL PATTERNS BETWEEN PROPERTY BOUNDARY AND BACK OF LAYBACK.

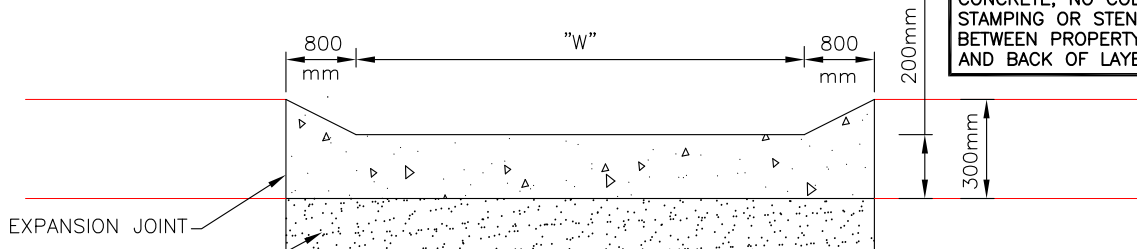

SECTION A
N.T.S

SAWCUT AND REINSTATE 500mm MINIMUM INTO ROAD PAVEMENT FROM FRONT EDGE OF CONCRETEWORKS UNLESS OTHERWISE INSTRUCTED BY COUNCIL'S INSPECTOR

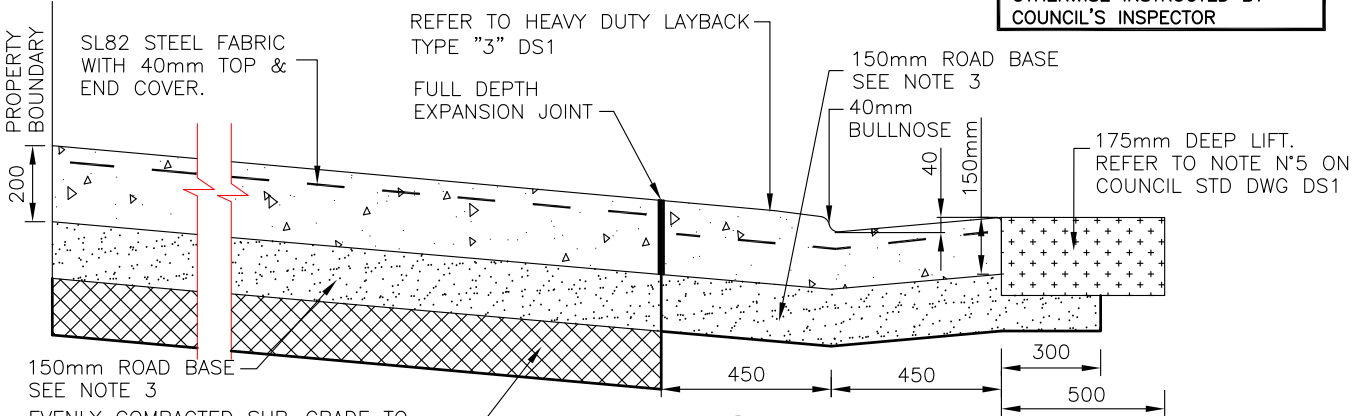

SECTION B
SCALE 1:20

* CONCRETE MINIMUM COMPRESSIVE STRENGTH TO BE (F_c) 25MPa AT 28 DAYS.

NOTES

1. ALL EXISTING KERB AND GUTTER SHALL BE REMOVED PRIOR TO ANY NEW LAYBACK WORKS UNLESS OTHERWISE DIRECTED BY COUNCIL'S INSPECTOR AT PRE-INSPECTION.
2. VEHICULAR CROSSING LEVELS TO BE IN ACCORDANCE WITH COUNCIL STD DWG DS10 AND DETAILED DESIGN.
3. ROAD BASE MATERIAL IS TO BE DGB20 OR SIMILAR AND COMPACTED TO 100% STANDARD MAXIMUM DRY DENSITY IN ACCORDANCE WITH A.S. 1289.5.1.1-2003
4. ALL DISTURBED AREAS TO BE TOPSOILED WITH 75mm OF APPROVED LOAM AND TURFED AS SOON AS PRACTICABLE (PRIOR TO FINAL INSPECTION) TO ENCOURAGE REVEGETATION AND MINIMISE SOIL EROSION FROM SITE.
5. EXISTING CONCRETE FOOTPAVING IS TO BE RECONSTRUCTED AS REQUIRED BY COUNCIL'S INSPECTOR OR PROJECT MANAGER TO MATCH THE CROSSING.
6. THE FOOTWAY IS TO BE SHAPED AS REQUIRED BY COUNCIL'S INSPECTOR OR PROJECT MANAGER TO THE CROSSING EVENLY.
7. THIS PLAN DOES NOT APPLY FOR FOOTWAY WIDTHS LESS THAN 2.8m.
8. ALL SURFACES TO BE BROOM FINISHED.
9. USE 2.0m, IF DISTANCE BETWEEN INVERT AND FRONT OF FOOTPATH IS 2.0m OR GREATER, WHERE DISTANCE IS LESS THAN 2.0m WING TO MATCH FRONT OF FOOTPATH

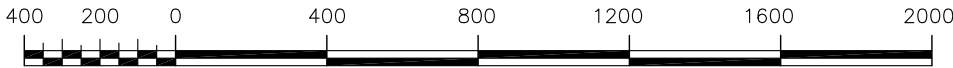

SCALE OF MILLIMETRES 1:20

DESIGNED / DRAWN		Date:	Scale: AS SHOWN	FINAL	CITY OF PARRAMATTA COUNCIL	PLAN N°	
DESIGN CHECKED & APPROVED		Date:	ASSET OWNER	Date:		HEAVY DUTY VEHICULAR CROSSING	DS9
SERVICE MANAGER CAPITAL PROJECTS		Date:	MANAGER CITY ASSETS & ENVIRONMENT	Date:		PLAN, SECTIONS AND NOTES	Sheet No : 1 of 1 Revision :

**THESE PROFILES ARE TO BE USED AS A GUIDE ONLY.
EACH DRIVEWAY SHOULD BE DESIGNED TO AVOID SCRAPING, DRAINAGE PROBLEMS
AND CONFLICTS WITH OSD LEVELS.**

**ROAD CROSSFALL WILL AFFECT
MAXIMUM ALLOWABLE GRADES**

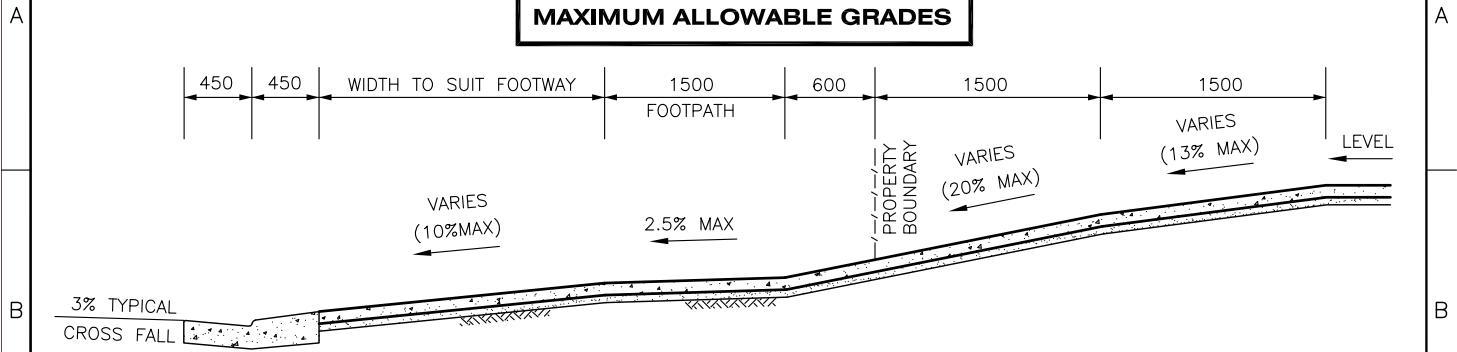

**VEHICULAR CROSSING: HIGH LEVEL
TYPICAL SECTION**
N.T.S.

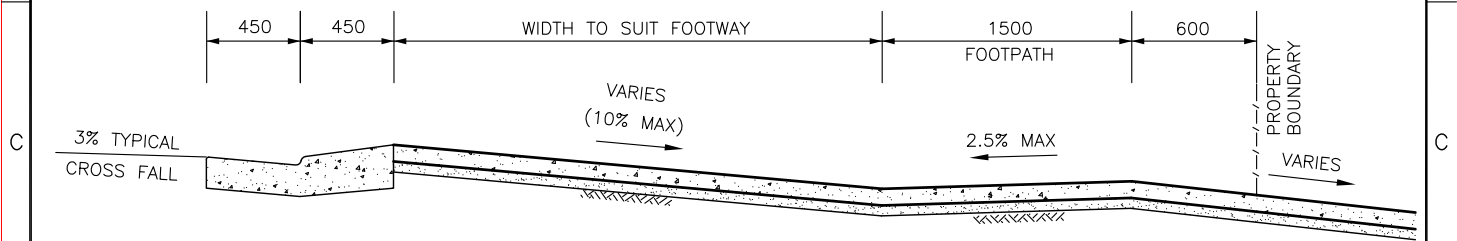

**VEHICULAR CROSSING: LOW LEVEL
TYPICAL SECTION**
N.T.S.

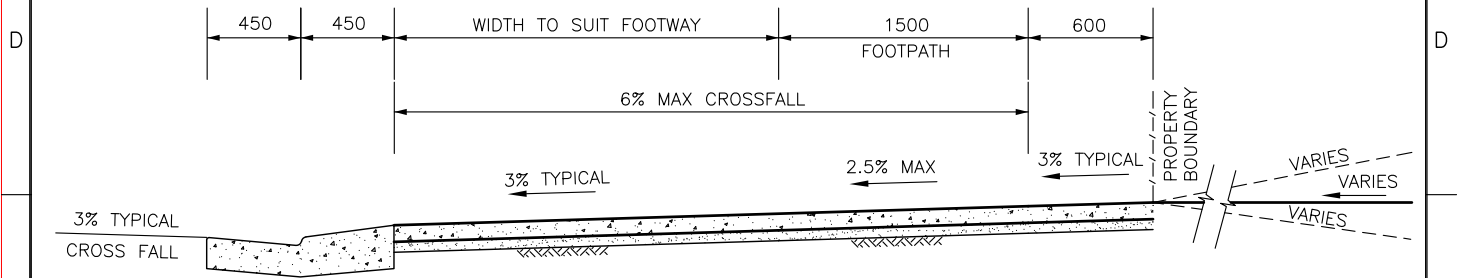

**VEHICULAR CROSSING: NORMAL LEVEL
TYPICAL SECTION**
N.T.S.

ALL DIMENSIONS SHOWN ARE IN MILLIMETRES

NOTES

1. MAX CROSSFALLS ARE ADVISORY ONLY. MAXIMUM LEVELS WILL ONLY BE APPROVED BY COUNCIL IN EXCEPTIONAL CIRCUMSTANCES. ANY OTHER GRADE ARRANGEMENT (DRIVEWAY DESIGN) SHALL BE DESIGNED BY A SUITABLY QUALIFIED, PROFESSIONAL ENGINEER AND LONGITUDINAL SECTION IN 1:20 SCALE SHALL BE SUBMITTED TO COUNCIL FOR FORMAL CHECK AND APPROVAL. PLAN TO SHOW CORRECT ROAD CROSSFALL.
2. CROSSING LEVELS TO BE DESIGNED TO ALLOW COUNCIL'S STANDARD CAR (85% VEHICLE) TO PASS WITHOUT SCRAPING. (COUNCIL STANDARD DRAWING DS7)
3. SPECIAL CONSIDERATION IS REQUIRED TO ALLOW "NON-STANDARD" AND "MODIFIED" VEHICLES TO CROSS WITHOUT SCRAPING E.G. A STANDARD VEHICLE MODIFIED WITH A TOW BAR, TRAILER, ETC.
4. VEHICULAR CROSSINGS CAN ONLY BE CONSTRUCTED IN ACCORDANCE WITH COUNCIL APPROVED PLANS AND TO RELEVANT COUNCIL STANDARD DRAWING DS8 OR DS9.
5. FOOTPAVING EXPANSION JOINTS SHALL BE PREFORMED BITUMEN IMPREGNATED FIBREBOARD 10mm WIDE, FULL CONCRETE DEPTH AT NO MORE THAN 6m SPACING WITH TOOLED 10mm DEEP, 10mm WIDE DUMMY JOINTS AT 1.5m SPACING.
6. ALL WORKMANSHIP AND MATERIALS TO RELEVANT, AUSPEC AND AUSTRALIAN STANDARDS

DESIGNED / DRAWN Date:	Scale: AS SHOWN	FINAL	CITY OF PARRAMATTA COUNCIL	PLAN N°	
	DESIGN CHECKED & APPROVED Date:	ASSET OWNER		Date:	VEHICULAR CROSSING PROFILES
	SERVICE MANAGER CAPITAL PROJECTS Date:	MANAGER CITY ASSETS & ENVIRONMENT		Date:	SECTIONS AND NOTES
				DS10	
				Sheet No : 1 of 1	
				Revision :	